











(1) Top  1PCS	(2) End Panel  2PCS	(3) Modesty Panel  1PCS	(A) Dowel  10PCS+1	(B) Cam Pin  10PCS+1	(C) Cam Lock  10PCS+1	(D) Cam Cover  10PCS+1	(E) Leg leveler  4PCS	(F) Grommet  3PCS
--	---	---	--	--	--	--	---	---

STEP 3

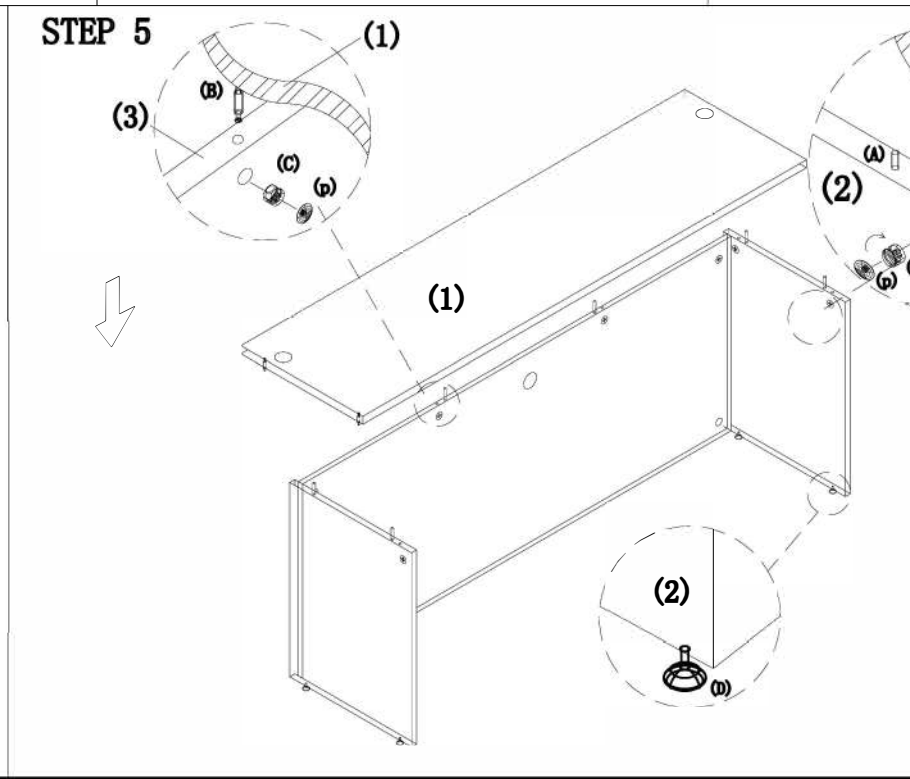
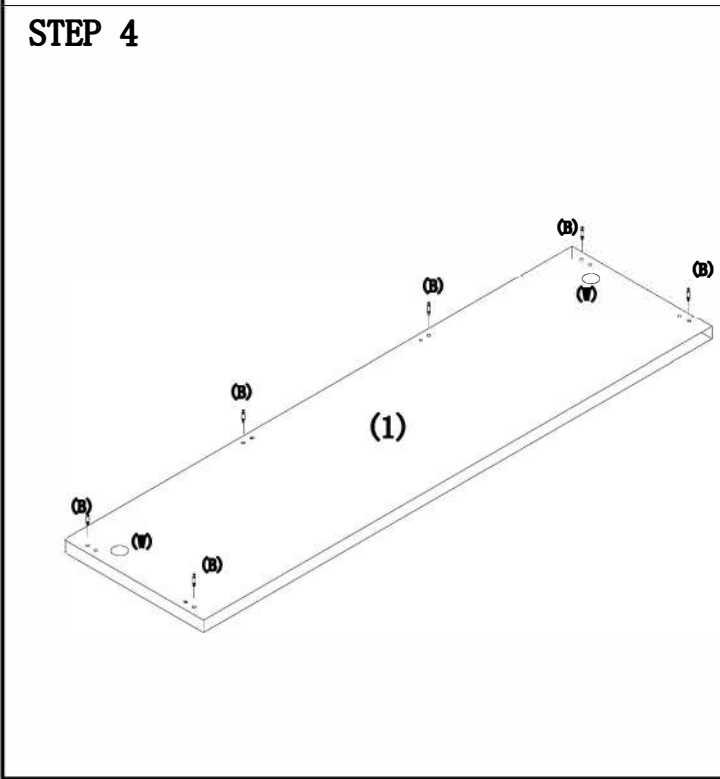
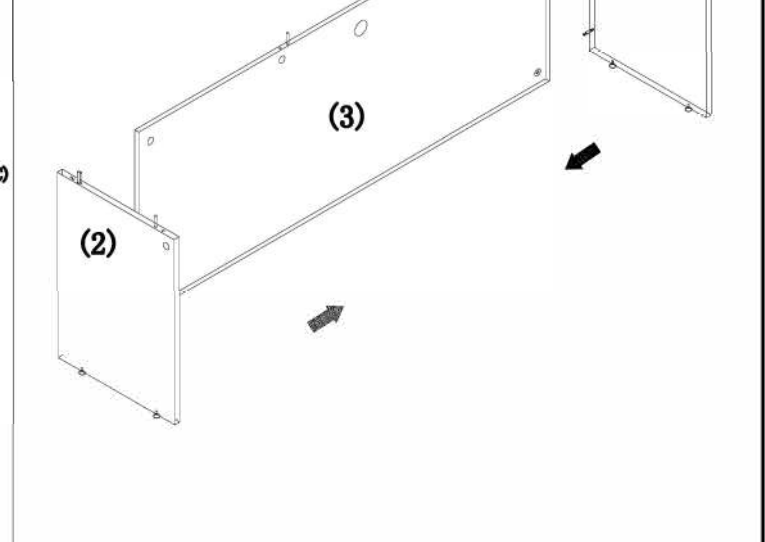
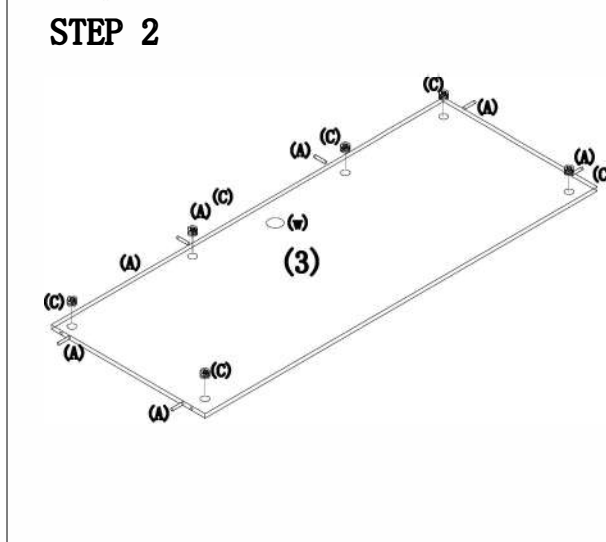
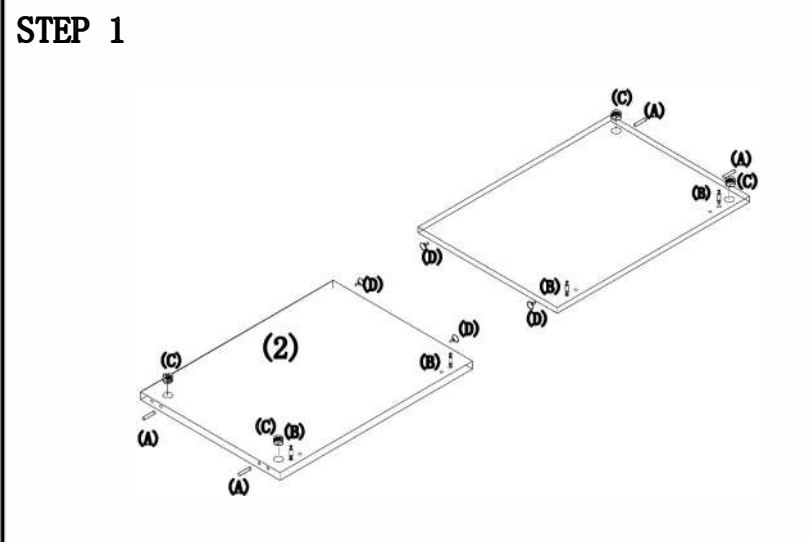

CREDENZA SHELL, 71*24
NAP-43
 71"W*24"D*29"H



Always lay components on A clean, soft-cushioned surface during assembly.